

NOTES

1. CONCRETE - 4000psi, AIR ENTRAINED
2. REINFORCING STEEL - GRADE 60, ASTM A-615
3. WELDED WIRE FABRIC - 3x12xw3/w2 ASTM A-185
4. LADDER RUNGS - COPOLYMER POLYPROPYLENE PLASTIC w/1/2" REBAR, GRADE 60
5. MATERIAL AND CONSTRUCTION SHALL COMPLY WITH PENNDOT PUB. 408, 72, RC39, & A.S.T.M. C478, C890, C913, C1443 and C1557
6. FRAME AND COVER - SEE ACCOMPANYING SPEC. SHEET
7. LOCATIONS OF PIPE OPENINGS AS REQUIRED
8. ALL MATERIAL USED MADE IN THE USA

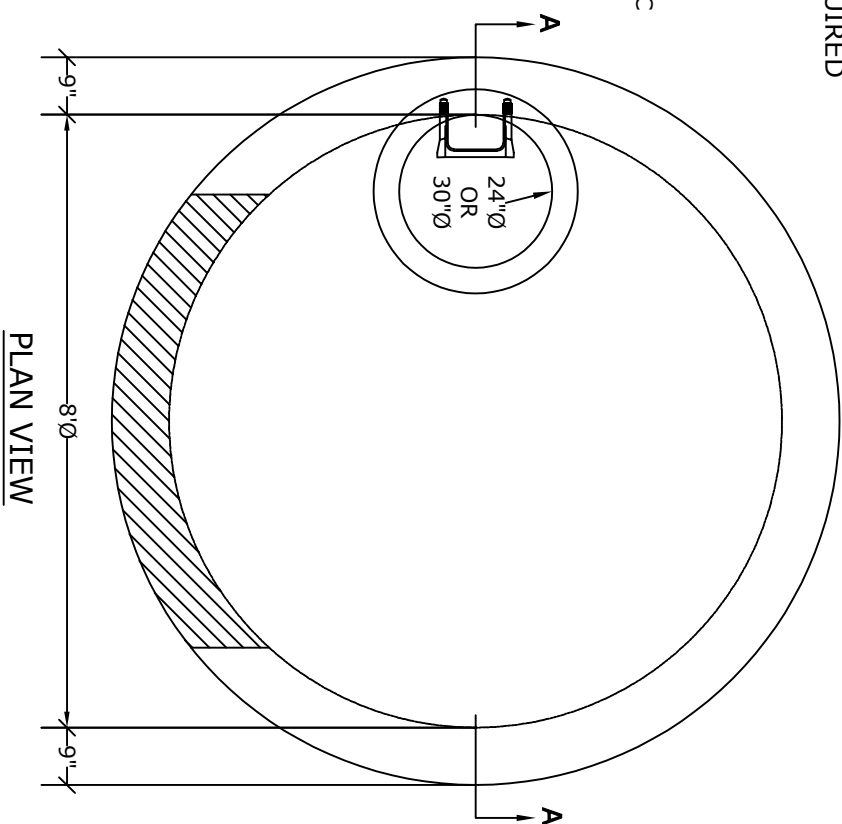
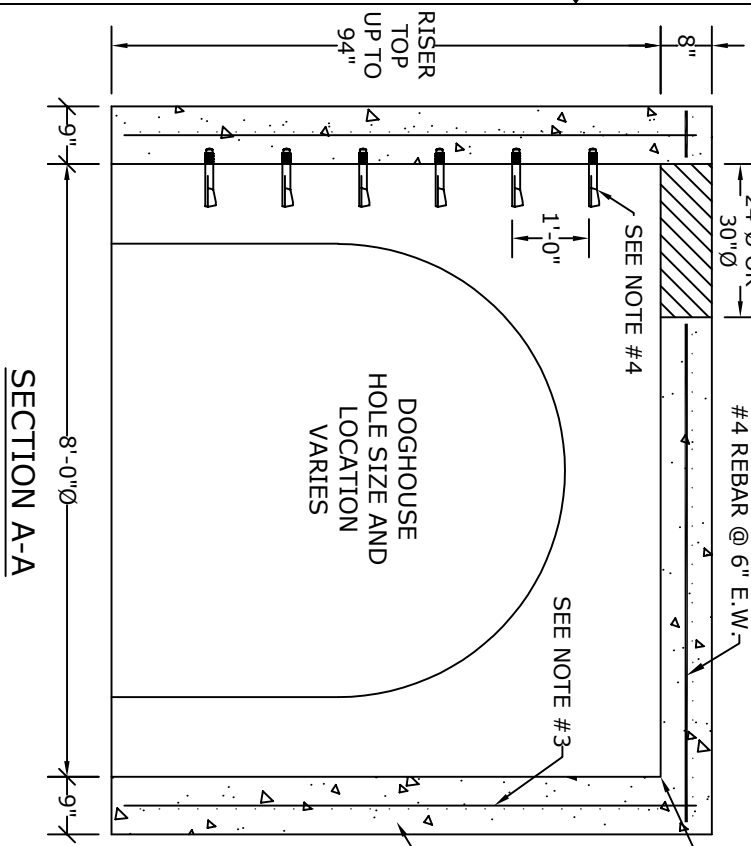

ALTOMARE PRECAST, INC.
 4300 Wissahickon Ave.
 Philadelphia, PA 19129
 Ph: 215-225-8800 Fax: 215-225-8900

TITLE:
 8'Ø
 Doghouse Manhole

PROJECT:
CONTR:
DATE: