

PLAN VIEW

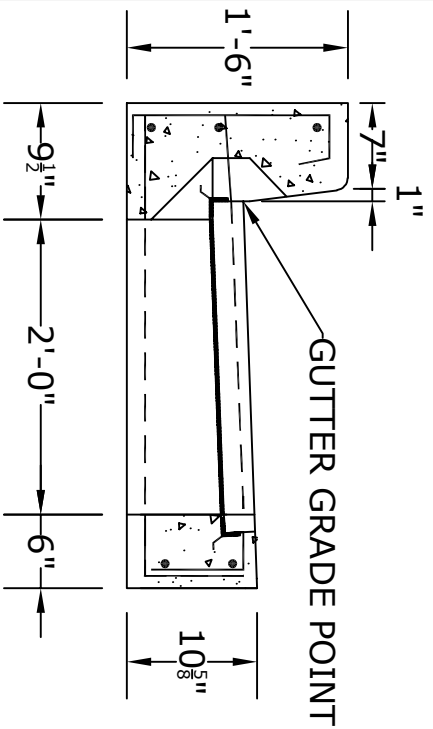

SECTION A

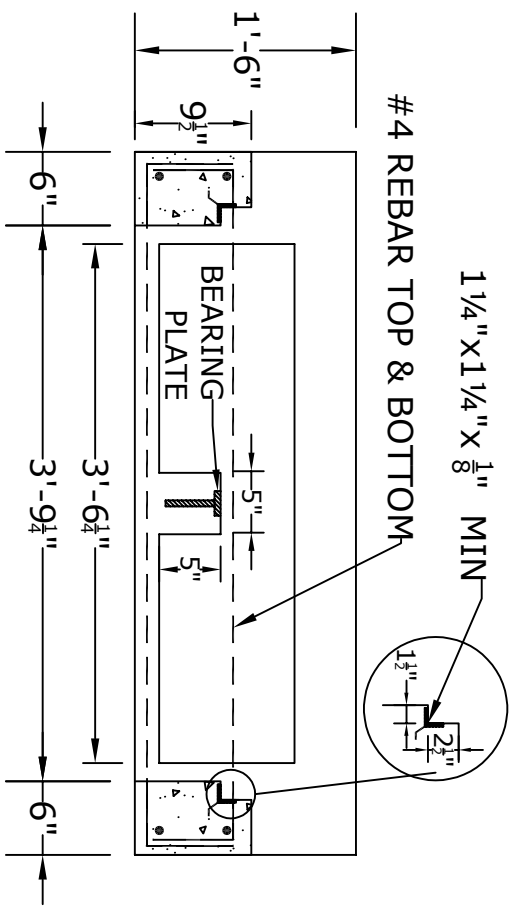

SECTION B

NOTES

1. CONCRETE - 4000psi, AIR ENTRAINED
2. REINFORCING STEEL - GRADE 60, ASTM A-615
3. GRATE - SEE ACCOMPANYING SPEC. SHEET
4. PER RC-34 AND PUB. 408
5. ALL MATERIAL USED MADE IN THE USA

ALTOMARE PRECAST, INC.
 4300 Wissahickon Ave.
 Philadelphia, PA 19129
 Ph: 215-225-8800 Fax: 215-225-8900

TITLE:
 PennDOT RC-34
 Type "C" Top (8" Curb)

PROJECT: Taco Bell
CONTR: Huebner
DATE: Dec. 19, 2018