

5954 Catch Basin Trap

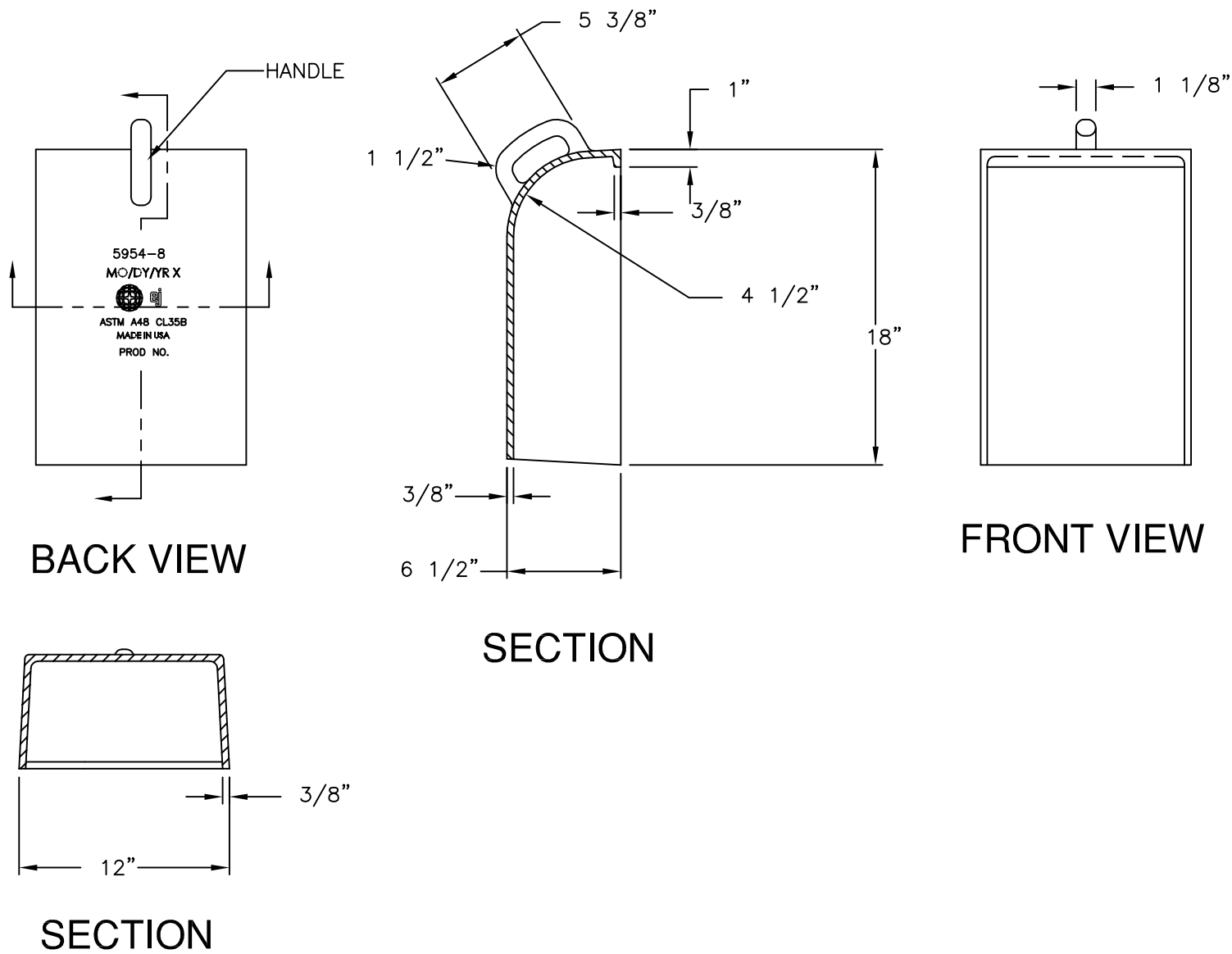

Product Number

00595467

Design Features

- Materials
Gray Iron (CL35B)
- Design Load
Heavy Duty
- Open Area
n/a
- Coating
Undipped
- √ Designates Machined Surface

Certification

- ASTM A48
-
-
- Country of Origin: USA

Drawing Revision

3/5/2001 Designer: SBB
6/8/2015 Revised By: DAE

Disclaimer

Weights (lbs./kg) dimensions (inches/mm) and drawings provided for your guidance. We reserve the right to modify specifications without prior notice.

CONFIDENTIAL: This drawing is the property of EJ GROUP, Inc., and embodies confidential information, registered marks, patents, trade secret information, and/or know how that is the property of EJ GROUP, Inc. Copyright © 2012 EJ GROUP, Inc. All rights reserved.

Contact

800 626 4653
ejco.com