

EAST JORDAN IRON WORKS, INC.
P.O. BOX 439
EAST JORDAN, MI. 49727
1-800-874-4100
FAX 231-536-4458

DRAWN SBB	DATE 04/18/05
APPROVED	DATE

WATER TIGHT ASSEMBLY

PRODUCT NO.
00104509

CATALOG NO.
1040APT
1045ZPT

REF. PRODUCT DRAWING
00104512
00104174

EST. WT.
COVER: 150 LBS 68kg
FRAME: 165 LBS 75kg
UNIT: 315 LBS 143kg

OPEN AREA
N/A

MAT'L SPEC.
COVER - GRAY IRON
ASTM A48 CL35B
FRAME - GRAY IRON
ASTM A48 CL35B

LOAD RATING
HEAVY DUTY (H-25)

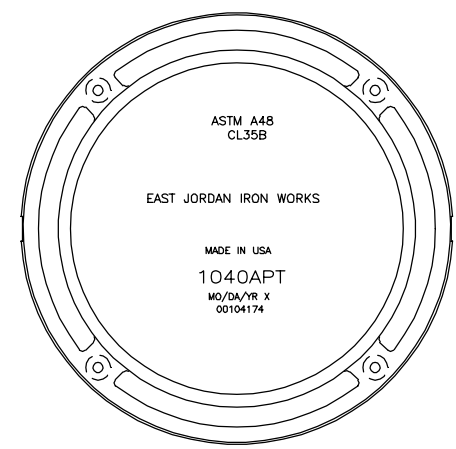
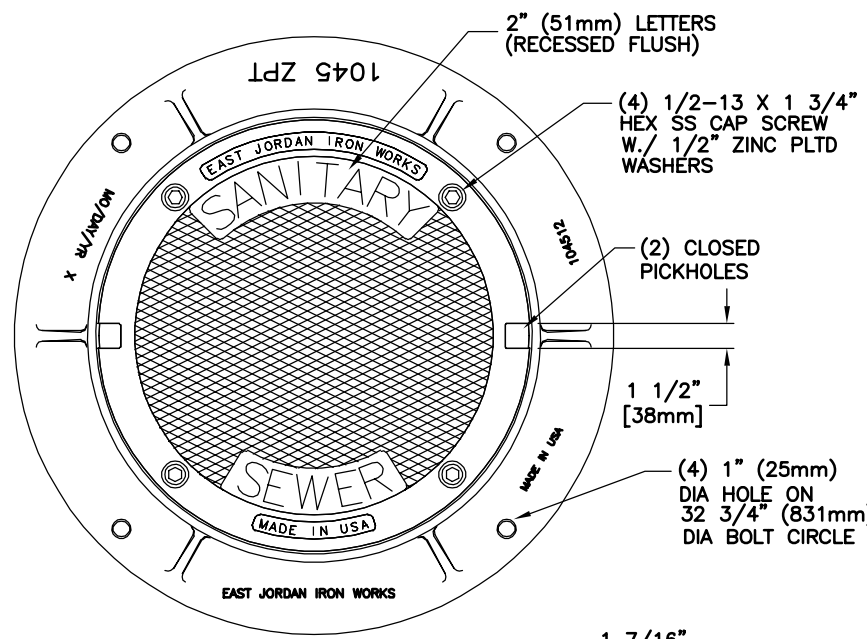

BOTTOM VIEW

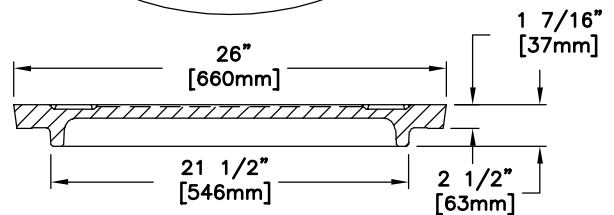

COVER SECTION

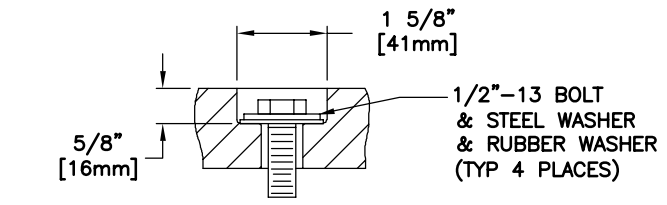

BOLT DETAIL

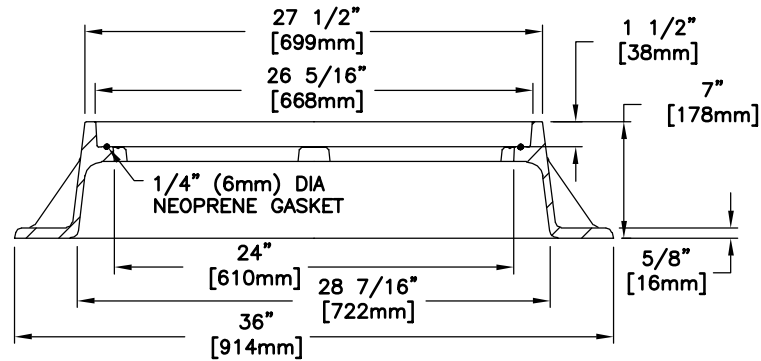

FRAME SECTION

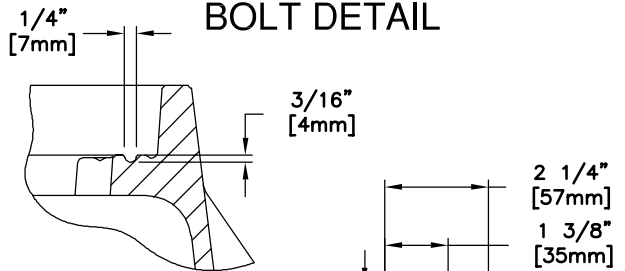

GROOVE DETAIL

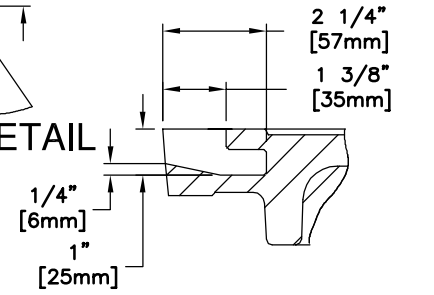

PICKHOLE DETAIL