

EAST JORDAN
IRON WORKS, INC.
P.O. BOX 439
EAST JORDAN, MI. 49727
1-800-874-4100
FAX 231-536-4458

| | |
|--------------|------------------|
| DRAWN KMB | DATE 05/31/06 |
| APPROVED | DATE |

**WT MANHOLE
ASSEMBLY**

PRODUCT NO.
(UNDIPPED)

CATALOG NO.
1310APT
1310ZPT

REF. PRODUCT DRAWING
00131043
00131013

EST. WT.
COVER: 124 LBS 55kg
FRAME: 167 LBS 82kg
UNIT: 291 LBS 132kg

OPEN AREA
N/A

MAT'L SPEC.
FRAME - GRAY IRON
ASTM A48 CL35B
COVER - GRAY IRON
ASTM A48 CL35B

LOAD RATING
HEAVY DUTY

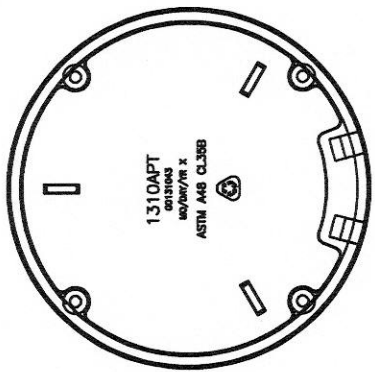

BOTTOM VIEW
OF COVER

(4) 1/2"-13 X 1 3/4"
HEX HD SS CAP SCREWS
W./ STEEL & RUBBER WASHERS

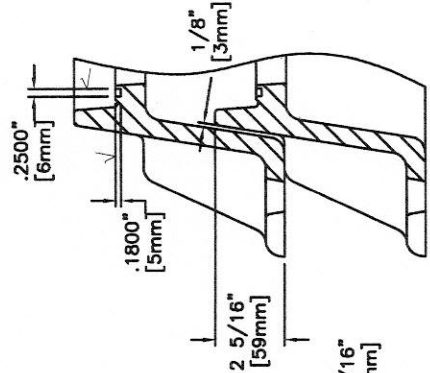

STACKING & GASKET
GROOVE DETAIL

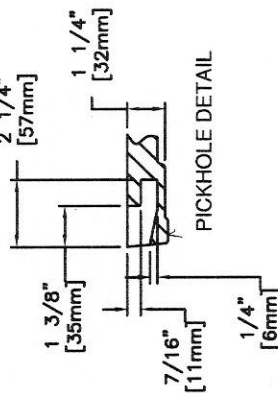

PICKHOLE DETAIL

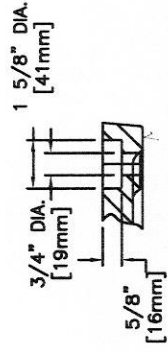

BOLT HOLE DETAIL

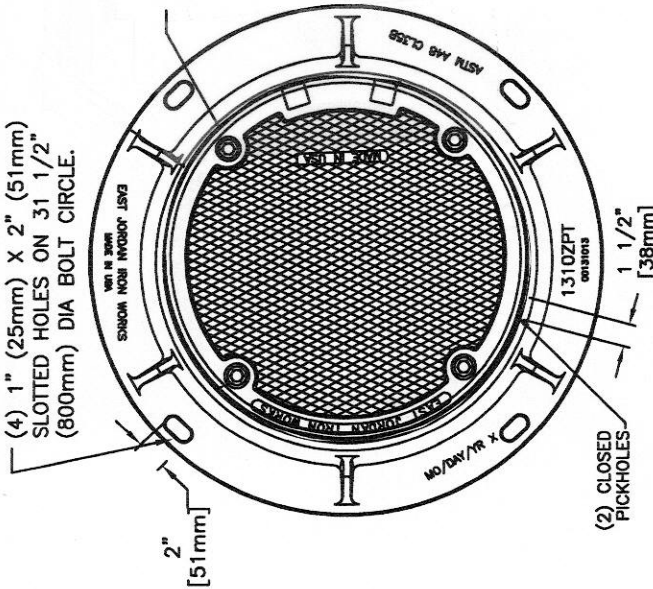

(2) CLOSED
PICKHOLES

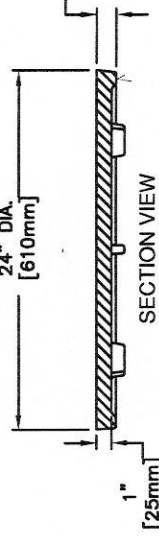

SECTION VIEW

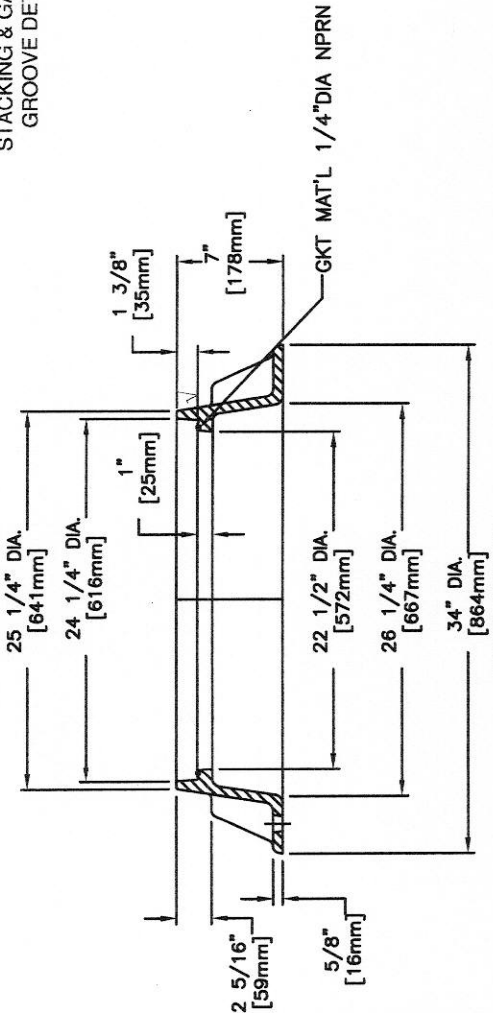

SECTION VIEW

✓ MACHINED SURFACE