

NOTES :

1. Structural steel grates coated with 1 coat of bituminous paint.
2. Tolerances shall be $\pm 1/8"$
3. Structural steel to meet or exceed requirements of AASHTO-M183 or ASTM-A36 .
4. Grate spacers to be flush with top surface of grate .
5. All welding is done by certified welders as per PA DOT pub. 408, sec. 1105.03 .

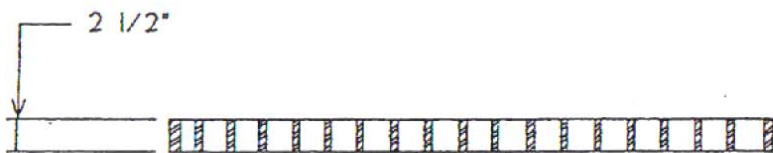

SECTION A-A

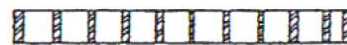

SECTION B-B

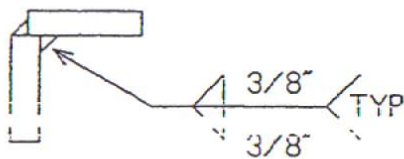

TYPICAL CORNER
DETAIL

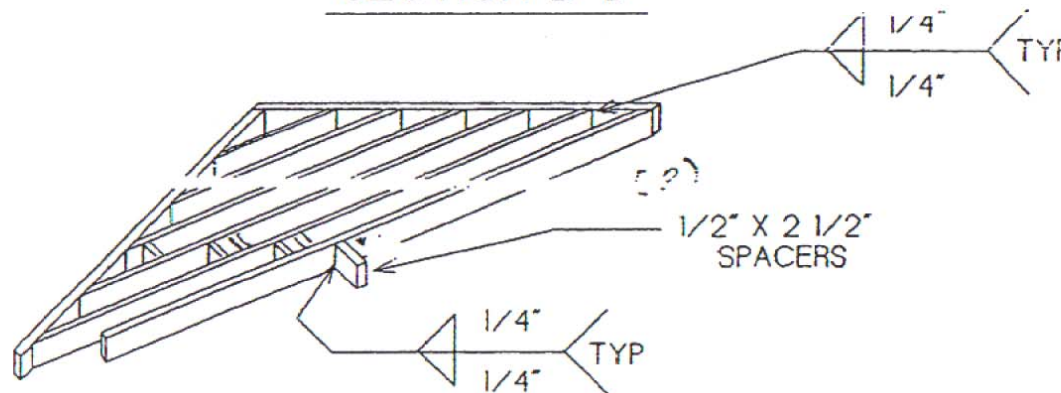

REVISIONS	BY

MORGAN'S WELDING
1841 Camp Avenue Road
Myerstown, PA 17067
Phone - 717-833-5255

DIAGONAL GRATE

DRAWN :	CHECKED :
TAB :	
DATE :	DATE :
SCALE :	
JOB NO. :	
SHEET	
1	
OF 1 SHEET	